



Graphite (Finish ID:61)

JAZZ BACK TO BACK DOOR PULL WITH BACK PLATE

“The juxtaposition of two surfaces where knurled meets smooth.
The contrast highlights the detail.”

	Item Code	Size (mm & Inches)	Material	Size (Inches)				Fig.
				A	B	C	D	
1	DDP.841.12".XX.XXX.XXXX	304.8mm (12")	Brass	14.21	1.24	12	2.28	1
2	DDP.841.18".XX.XXX.XXXX	457.2mm (18")	Brass	20.39	1.24	18	2.28	1
3	DDP.841.24".XX.XXX.XXXX	609.6mm (24")	Brass	26.42	1.24	24	2.28	1
4	DDP.841.36".XX.XXX.XXXX	914.4mm (36")	Brass	38.39	1.24	36	2.28	1
5	DDP.841.48".XX.XXX.XXXX	1219.2mm (48")	Brass	50.47	1.32	48	2.28	1

“XX” in item code denotes Finish ID.
“XXX” in item code denotes Door Thickness.
“XXXX” in item code denotes Door Material.

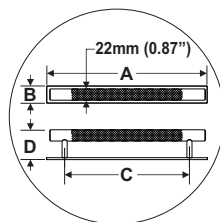
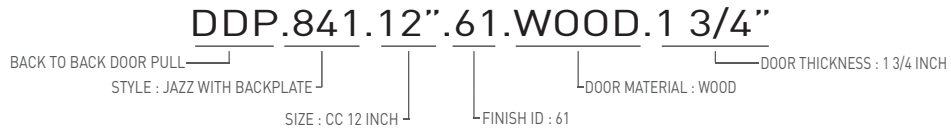



























FIG. 1

This product is Supplied with Mounting Kit including with the Order.

How to Order



Jazz Back To Back Door Pull With Back Plate Finish Options

Base Material : Brass	Standard Finishes (2-3 Weeks Delivery)					
						
Bright Chrome (Finish ID:2)	Brush Nickel (Finish ID:3)	Aged Brass (Finish ID:4)	Unlacquered Polished Brass (Finish ID:7U)	Polished Nickel (Finish ID:8)	Satin Brass (Finish ID:13)	
Base Material : Brass	Custom Finishes (3-4 Weeks Delivery)*					
						
Lacquered Polished Brass (Finish ID:7L)	Matte Black (Finish ID:19)	Split Black and Polished Nickel with Polished Nickel Back Plate (Finish ID:48A)	Split Black and Polished Nickel with Black Back Plate (Finish ID:48B)	Split Black and Satin Brass with Satin Brass Back Plate (Finish ID:49A)	Split Black and Satin Brass with Black Back Plate (Finish ID:49B)	Split Black and Chrome with Chrome Back Plate (Finish ID:59A)
						
Split Black and Chrome with Black Back Plate (Finish ID:59B)	Graphite (Finish ID:61)	Split Brush Nickel and Satin Brass with Satin Brass Back Plate (Finish ID:78A)	Split Brush Nickel and Satin Brass with Brush Nickel Back Plate (Finish ID:78B)	Titanium (Finish ID:79)	Split Graphite and Satin Brass with Satin Brass Back Plate (Finish ID:90A)	Split Graphite and Satin Brass with Graphite Back Plate (Finish ID:90B)
						
Split Graphite and Brush Chrome with Graphite Back Plate (Finish ID:91A)	Split Graphite and Brush Chrome with Brush Chrome Back Plate (Finish ID:91B)	Ombre (Finish ID:92)	Split Graphite and Aged Brass with Graphite Back Plate (Finish ID:93A)	Split Graphite and Aged Brass with Aged Brass Back Plate (Finish ID:93B)	Brush Chrome (Finish ID:95)	

Door Material	Door Thickness
1. Wood	5/16", 3/8", 1/2", 3/4", 1", 1 1/4", 1 1/2", 1 3/4", 2", 2 1/4", 2 1/2"
2. Metal	5/16", 3/8", 1/2", 3/4", 1", 1 1/4", 1 1/2", 1 3/4", 2", 2 1/4", 2 1/2"
3. Glass	5/16", 3/8", 1/2", 3/4", 1"

- Custom finishes cannot be returned or refunded. We are unable to accept cancellations for custom finish order unless within 48 hours of the order being placed.
- We have uniform pricing for all non-hammered finishes listed above as long as base material and size is same.
- Contact us for customized finishes, refer pages F1, F2, F3 & F4 for finish glossary.

Jazz Back To Back Door Pull With Back Plate Split Finish

DDP.841.XX.XX

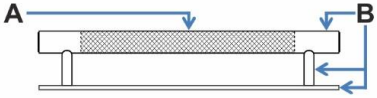
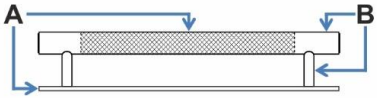
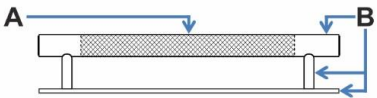
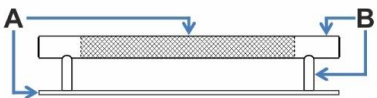
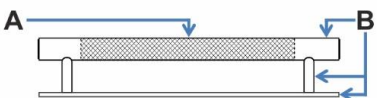
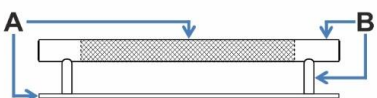
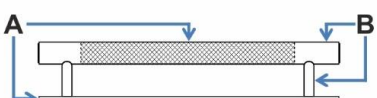
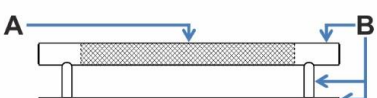
FINISH CODE (XX)	FINISH NAME	LINE DRAWING	A	B
DDP.841.XX.48A	Split Black and Nickel with Polished Nickel Back Plate		Matte Black	Polished Nickel
DDP.841.XX.48B	Split Black and Nickel with Black Back Plate		Matte Black	Polished Nickel
DDP.841.XX.49A	Split Black and Satin Brass with Satin Brass Back Plate		Matte Black	Satin Brass
DDP.841.XX.49B	Split Black and Satin Brass with Black Back Plate		Matte Black	Satin Brass
DDP.841.XX.59A	Split Black and chrome with chrome back plate		Matte Black	Bright Chrome
DDP.841.XX.59B	Split Black and chrome with Black back plate		Matte Black	Bright Chrome
DDP.841.XX.78A	Split Brush Nickel and Satin Brass with Satin Brass Back Plate		Satin Brass	Brush Nickel
DDP.841.XX.78B	Split Brush Nickel and Satin Brass with Brush Nickel Back Plate		Satin Brass	Brush Nickel

Jazz Back To Back Door Pull With Back Plate Split Finish

DDP.841.XX.XX

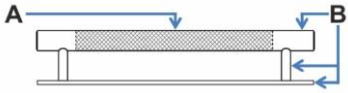
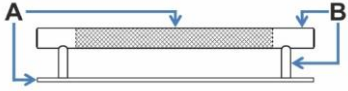
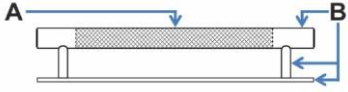
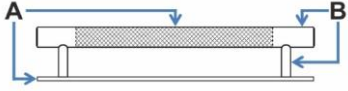
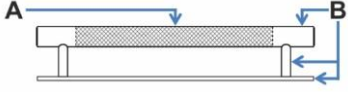
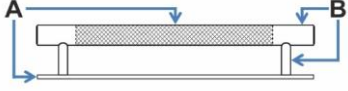
FINISH CODE (XX)	FINISH NAME	LINE DRAWING	A	B
DDP.841.XX.90A	Split Graphite and Satin Brass with Satin Brass Back Plate		Graphite	Satin Brass
DDP.841.XX.90B	Split Graphite and Satin Brass with Graphite Back Plate		Graphite	Satin Brass
DDP.841.XX.91A	Split Graphite and Brush Chrome with Brush Chrome Back Plate		Graphite	Brush Chrome
DDP.841.XX.91B	Split Graphite and Brush Chrome with Graphite Back Plate		Graphite	Brush Chrome
DDP.841.XX.93A	Split Graphite and Aged Brass with Aged Brass Back Plate		Graphite	Aged Brass
DDP.841.XX.93B	Split Graphite and Aged Brass with Graphite Back Plate		Graphite	Aged Brass

**BACK TO BACK
HANDLE ILLUSTRATED**

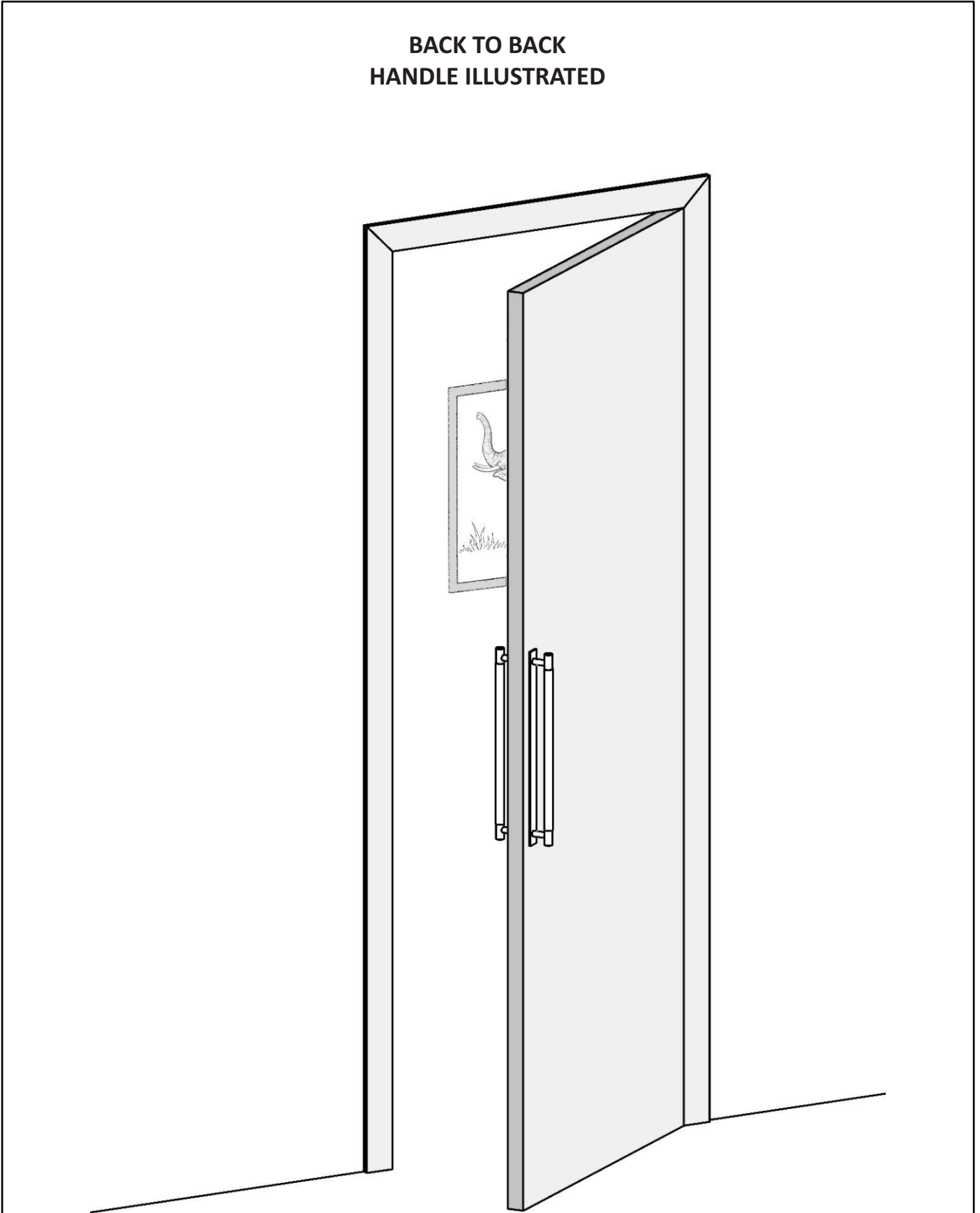

Required Tools

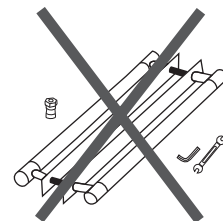
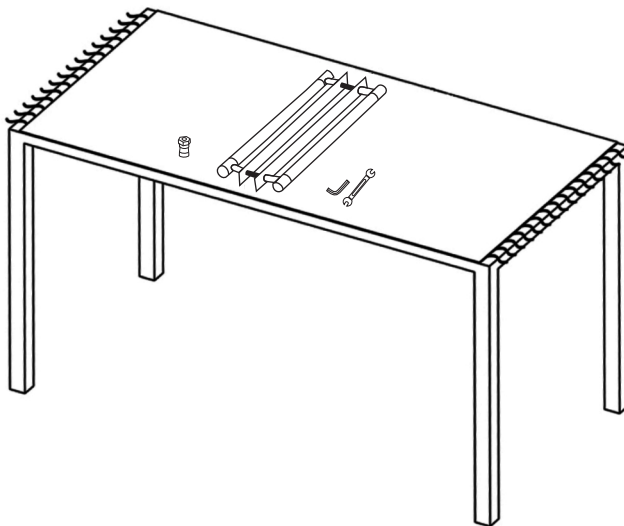
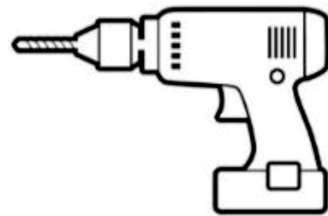
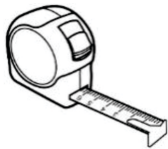

Step Wise Packing List			
S.No.	Part Number	Qty	Steps
1	DDP.841.XX.XX.XXX.XXXX	1x	1
2	SLEEVE	1x	1
3	LNKY2.5	1x	1
4	INSERT	1x	1
5	DDP.SPANNER (No.10,11)	1x	4
6	Manual	1x	-

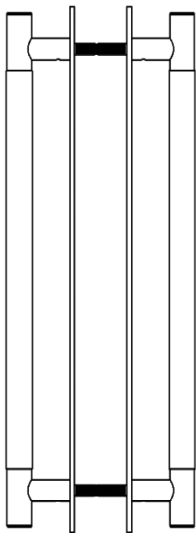
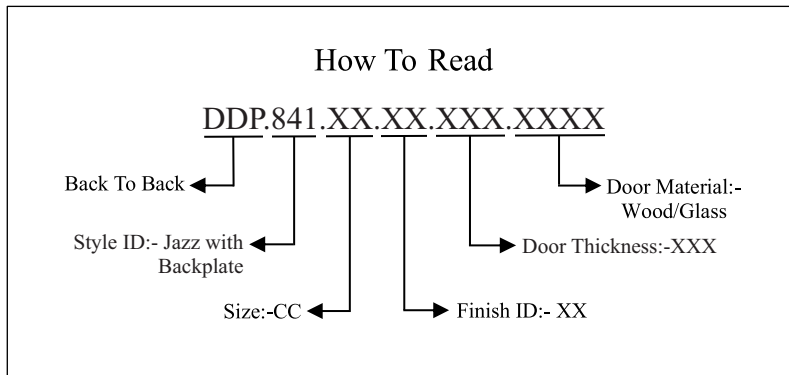

DDP.841.XX.XX.XXX.XXXX



LNKY2.5



INSERT

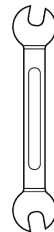

DDP.SPANNER (No.10,11)



STEP-1

Step Wise Packing List			
S.No.	Part Number	Qty	Steps
1	DDP.841.XX.XX.XXX.XXXX	1x	1
2	SLEEVE	1x	1
3	LNKY2.5	1x	1
4	INSERT	1x	1

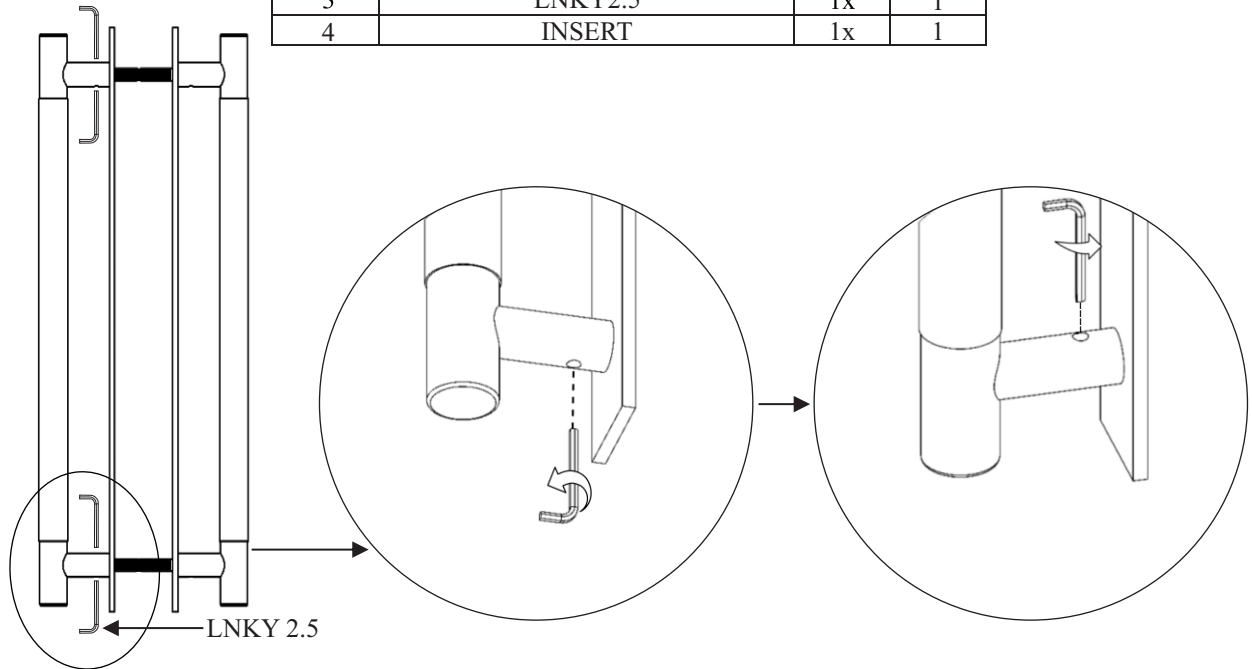

DDP.841.XX.XX.XXX.XXXX

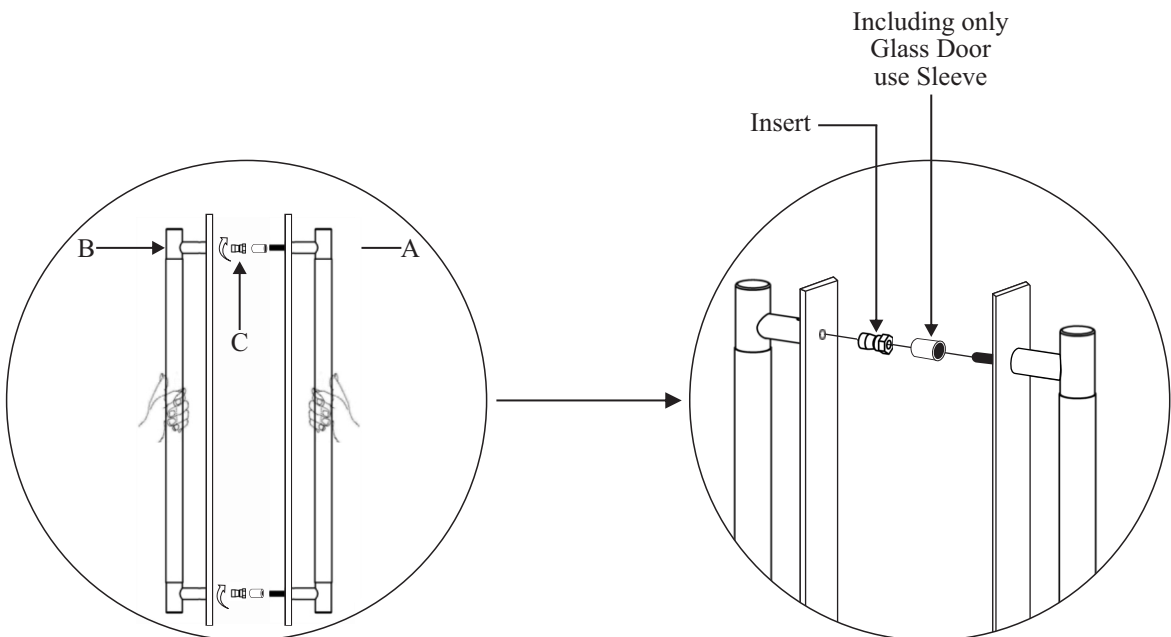

STEP-2

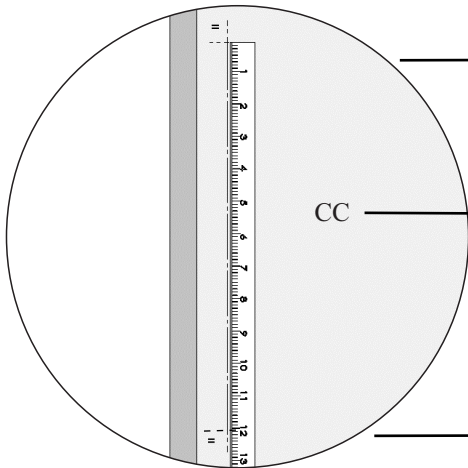
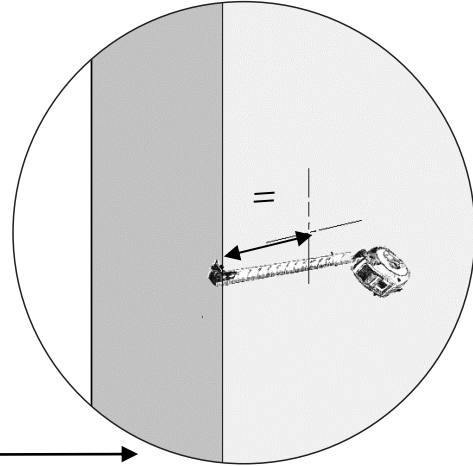
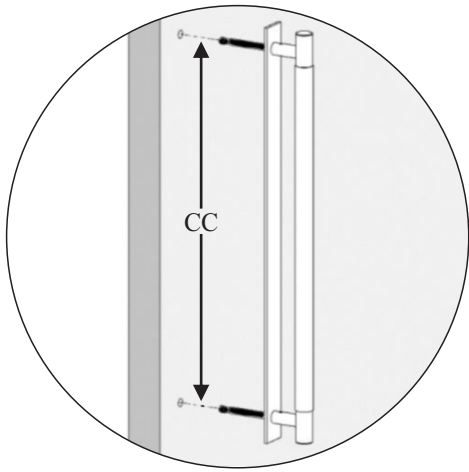

DDP.841.XX.XX.XXX.XXXX

Size:-CC

- 12"
- 18"
- 24"
- 36"
- 48"

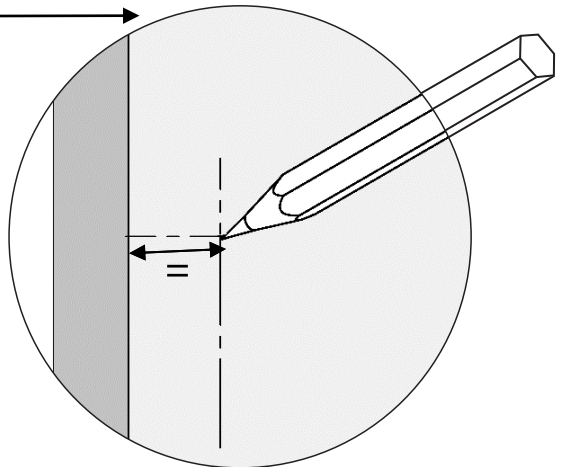
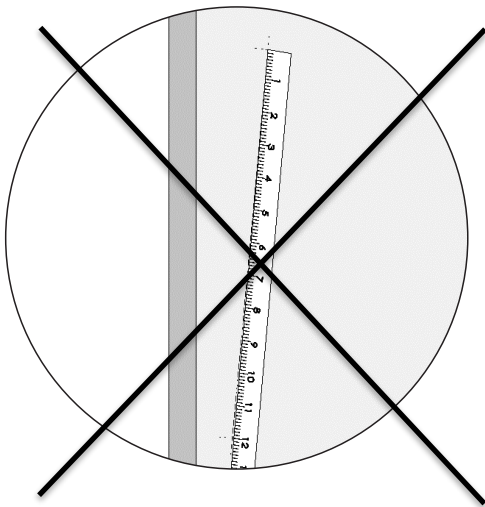

STEP-3

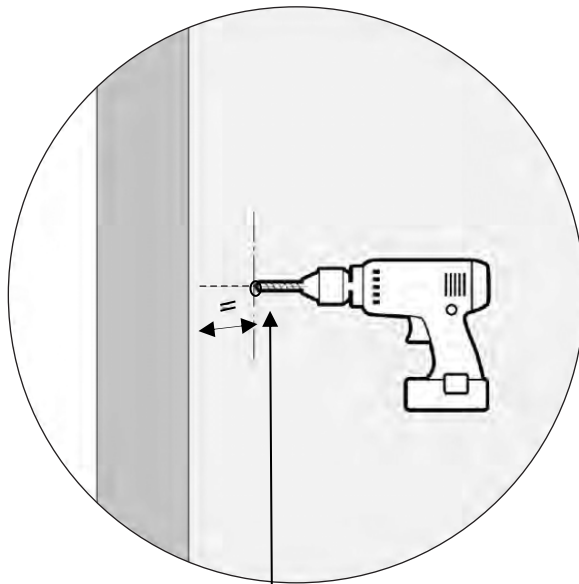
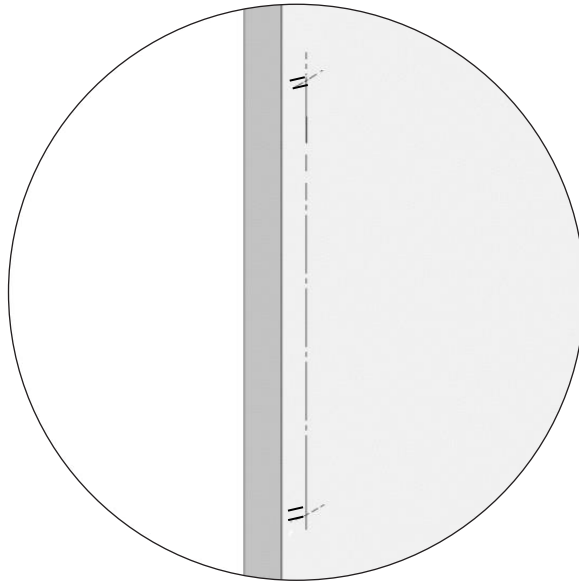

DRILL SIZE			
	Glass	Wood	Metal
DDP	3/8" (9.5mm)	1/4" (6.4mm)	1/4" (6.4mm)

STEP-4

Step Wise Packing List			
S.No.	Part Number	Qty	Steps
5	DDP.SPANNER (No.10,11)	1x	4

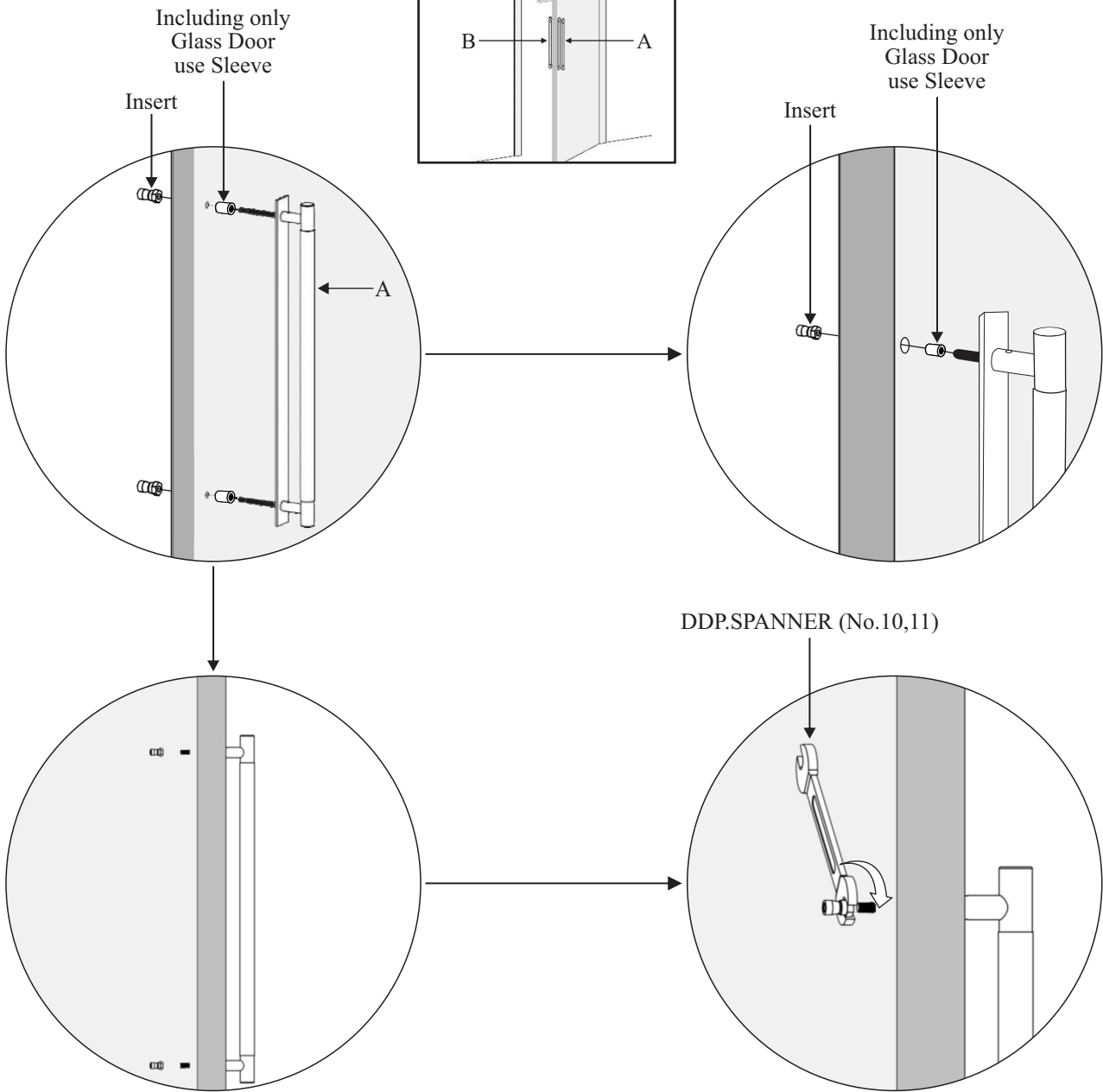
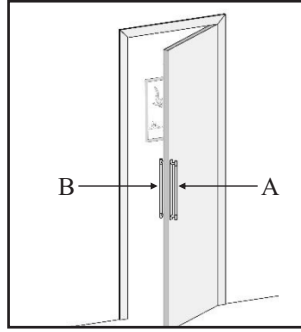

STEP-5

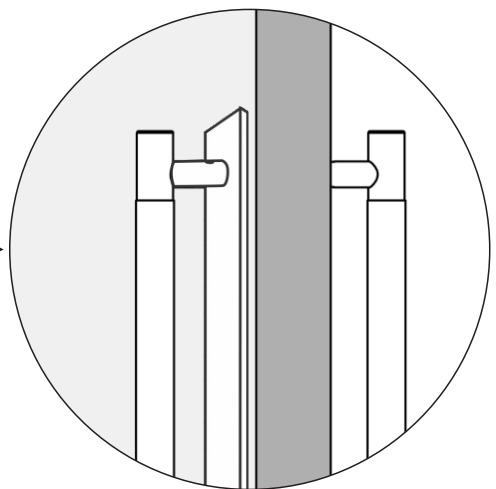
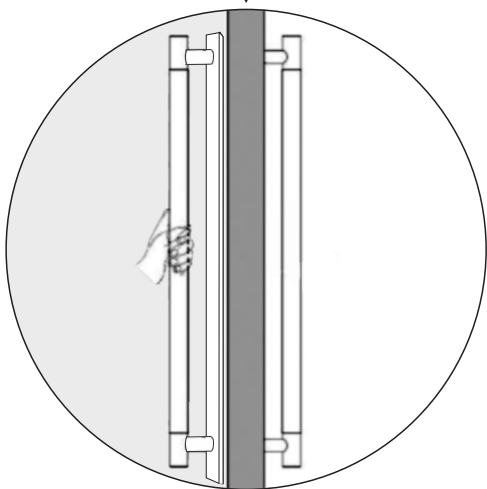
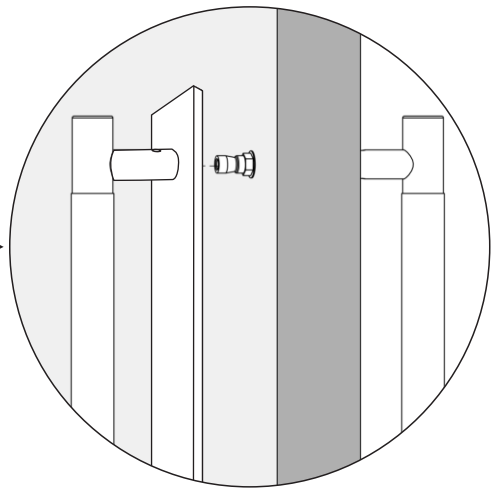
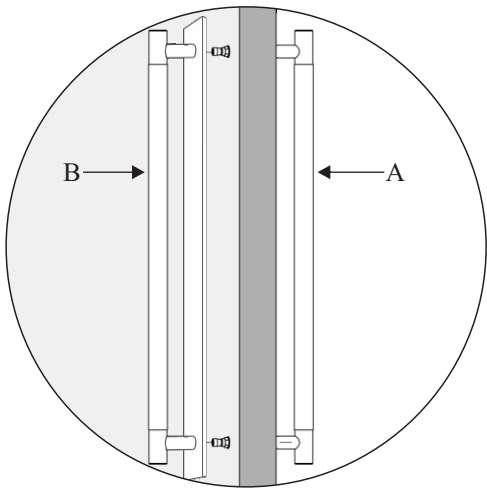
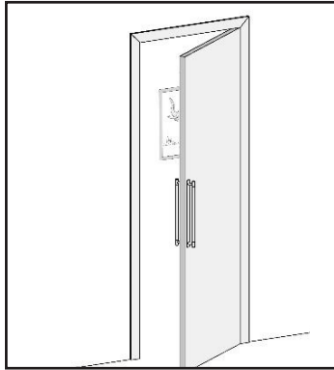

STEP-6

